



OWNER'S MANUAL

AIR PURIFIER

Read this owner's manual thoroughly before operating the appliance and keep it handy for reference at all times.

Model name : AS65GD Series



MFL70445409
Rev.03_020520

www.lg.com
Copyright © 2019 - 2020 LG Electronics Inc. All Rights Reserved.

TABLE OF CONTENTS

This manual may contain images or content different from the model you purchased.
This manual is subject to revision by the manufacturer.

SAFETY INSTRUCTIONS.....04

INSTALLATION 11

- Parts..... 11
- Removing Packing Materials..... 12
- Remote Controller 13
- Transporting or Moving the Appliance.. 14
- Installing the Appliance..... 14

OPERATION 15

- Appliance Overview..... 15
- Getting Started.....21
- Using Smart Mode.....21
- Using Booster Mode.....22
- Using Normal Mode.....22
- Adjusting the Air Purifier Fan Speed23
- Adjusting the Clean Booster Fan Speed
.....23
- Rotating the Clean Booster 24
- Checking the Air Quality 25
- Using the Air Ionizer 28
- Setting the Sleep Timer 29
- Locking the Control Panel Buttons..... 29

SMART FUNCTIONS 30

- LG ThinQ Application..... 30
- Smart Diagnosis 32

MAINTENANCE 34

- Cleaning the Exterior 35
- Cleaning the Filter 36
- Replacing the Filter..... 36
- Cleaning the Particles Sensor 37
- Storage 38

TROUBLESHOOTING 39

APPLIANCE SPECIFICATIONS .. 43

SAFETY INSTRUCTIONS

The following safety guidelines are intended to prevent unforeseen risks or damage from unsafe or incorrect operation of the appliance.

The guidelines are separated into 'WARNING' and 'CAUTION' as described below.



This symbol is displayed to indicate matters and operations that can cause risk. Read the part with this symbol carefully and follow the instructions in order to avoid risk.



WARNING

This indicates that the failure to follow the instructions can cause serious injury or death.



CAUTION

This indicates that the failure to follow the instructions can cause the minor injury or damage to the product.

IMPORTANT SAFETY INSTRUCTIONS



WARNING

To reduce the risk of explosion, fire, death, electric shock, injury or scalding to persons when using this product, follow basic precautions, including the following:

Children in the Household

This appliance is not intended for use by persons (including children) with reduced physical, sensory or mental capabilities, or lack of experience and knowledge, unless they have been given supervision or instruction concerning use of the appliance by a person responsible for their safety. Children should be supervised to ensure that they do not play with the appliance.

Installation

- Do not install the appliance on an uneven or inclined surface.
- Do not install the appliance in an area exposed to direct sunlight or near heat-generating equipment.
- Do not install the product in a place where combustible gas may leak or industrial oil or metallic particulates are present.
- Be careful not to let the power plug pressed by the back of the appliance.
- Do not touch the power plug with wet hands.
- Make the connection securely so that screw in terminals may not be loosed when pulling cable.
- When unplugging the power cord, always pull it by the plug.
- Unplug the appliance during thunder or lightning or when not in use for a long time.
- Do not bend the power cable excessively or place a heavy object on top of it.
- Do not extend the length of the power cable or alter it.
- Do not use several devices on a multi-socket extension outlet.
- Take care to ensure that power cable could not be pulled out or damaged during operation.
- If the supply cord is damaged, it must be replaced by the manufacturer, its service agent or similarly qualified person in order to avoid a hazard.

Operation

- If the appliance is immersed in water, stop using it and contact the LG Electronics service centre.
- If there is a gas leakage (isobutane, propane, LNG, etc.), do not touch the product or power plug and ventilate the area immediately.
- Do not clean the appliance with brushes, cloths or sponges with rough surfaces or which are made of metallic material.
- If you detect any abnormal noise, odour or smoke, unplug the product immediately and contact an LG Electronics service centre.
- Only an authorized repair person from LG Electronics service centre should disassemble, repair, or modify the appliance.
- Do not use or store fire, combustibles (ether, benzene, alcohol, drugs, propane, butane, combustible spray, insecticide, air freshener, cosmetics etc.) or flammable materials (candles, lamps etc.) near the product.
- Do not place the power cord under rugs, carpeting or mats.
- Do not allow animals or pets to chew on the power cord.
- Do not allow children to climb on or play with the appliance.
- Do not move the appliance when it is in operation.
- The fan is not a toy. It should not be played with or placed where young children can reach it.
- Do not impact the appliance.
- Do not place anything (coffee, flower vase or drinks etc.) on top of the appliance.
- Do not insert hands or metal objects into the air inlet or outlet.
- Do not install and use broken parts.

- Do not put flammables into the appliance.
- Do not operate the appliance while its cover is open.

Maintenance

- Dispose of the packing materials (vinyl, styrofoam etc.) to keep them out of reach of children.
- Be careful not to allow any part of your body to be pinched when you detach and reattach parts of the appliance.
- You must stop operating the product and unplug the appliance before you clean the appliance and replace the filter.

Battery

- A button/coin-shaped battery is used in the remote controller of the appliance. If you accidentally swallowed the battery, go to the doctor immediately for emergency treatment. If you fail to receive first aid within 2 hours after you swallowed it, you may experience damage to your internal organs or death in severe cases.
- Do not swallow the battery.
- If the battery tray is not secured firmly, stop using the appliance instantly and keep it away from children.
- Replace the all batteries in the remote controller with new ones of the same type. Do not mix old and new batteries or different types of batteries.

CAUTION

To reduce the risk of minor injury to persons, malfunction, or damage to the product or property when using this product, follow basic precautions, including the following:

Installation

- Do not tilt the appliance to pull or push it when transporting.
- Do not install the appliance in transportation equipment (vehicle/vessel etc.).
- Do not place the appliance near a TV or a stereo equipment.
- Do not place the appliance under bright light.
- The appliance shall be installed in accordance with national wiring regulations.
- When moving or storing the appliance, wrap the power cord around the base of the appliance to prevent personal injury, damage to the cord or damage to floors.

Operation

- Do not use the product for removal of toxic gas such as carbon monoxide.
- Do not use the product for ventilation purposes.
- Do not use the appliance for a long time in a region with unstable voltage.
- Do not place obstacles around the air inlet or outlet.
- For safe use of the appliance, children or others with reduced mental capabilities need to be closely monitored by a person who is responsible for their safety.
- Do not place the appliance near curtains.
- Do not use the product for special purposes such as preserving plants, precision instrument, artworks etc.

- Do not climb or place objects on top of the appliance.
- Do not operate the appliance with wet hands.
- Do not let the moisture from the humidifier directly touch the appliance.
- Do not use the appliance while it is not in upright position.
- Do not use the appliance near objects vulnerable to heat.
- Use the filter only for its intended purpose.
- The Deodorizing Care Filter and Allergen Collection Care Filter are assembled together. Do not try to detach them from each other.
- Do not use detergents, cosmetics, chemicals, air fresheners, or disinfectants in the appliance.
- Do not place magnetic or metal objects on top of the appliance.
- Do not touch any internal parts while the unit is operating or immediately after operation.
- Do not operate the Booster arbitrarily.
- Do not insert any objects into the Booster.
- Do not operate the product while the Booster cover and grill are separated.
- Do not insert hands or metal objects into the moving part of the Clean Booster.
- Do not press multiple buttons at the same time on the remote controller.
- Do not kick or step on the remote controller.
- Do not use the remote controller where there is too much water or moisture.
- Do not use the remote controller where there is fire or heat.

Maintenance

- Do not clean with strong detergents of solvent types, but use soft cloth.
- Do not disassemble the clean booster arbitrarily.
- Do not clean the appliance with an alkaline detergent.
- Do not wipe the appliance surface using sulfuric acid, hydrochloric acid or organic solvent (thinner, kerosene etc.) or attach a sticker on the appliance.
- Do not allow the water enter inside the appliance.
- Do not wash the filter with water.
- Be careful not to damage the ultra fine filter when you use a vacuum cleaner.

Battery

- Do not modify the battery arbitrarily.
- Misplaced battery may cause an explosion.
- Do not recharge or take apart the battery.
- Do not throw the battery in the fire for disposal or leave it near the heat.
- Remove and store the battery in a safe location if you don't intend to use the remote controller for a long time.

INSTALLATION

Parts

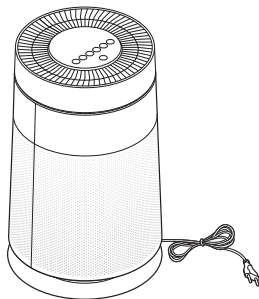

Air Purifier

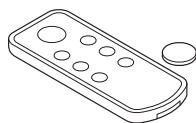

Remote Controller /
Battery (CR2025, 1 Unit)

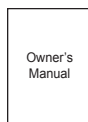

Owner's Manual

- The appearance or components of the appliance may differ depending on the model.
- The shape of the power plug differs depending on the country.

Removing Packing Materials

Unpack the appliance and remove any packing tape or vinyl before using the appliance.

- 1 Pull out the appliance from the packaging and remove the fixing tape attached on the appliance.
- 2 Grab the top end of the back cover and gently pull it.
 - You will see "PM1.0 & GAS SENSOR SYSTEM" on the back cover of the appliance.

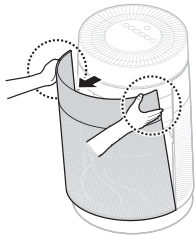

- 3 Remove the cover from the appliance.

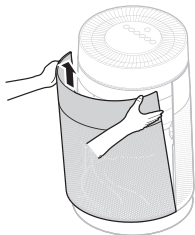

- 4 Remove the support located at the filter inlet.

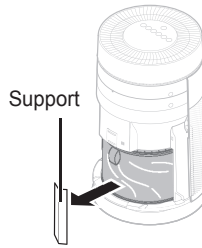

- 5 Remove the filter and its vinyl.

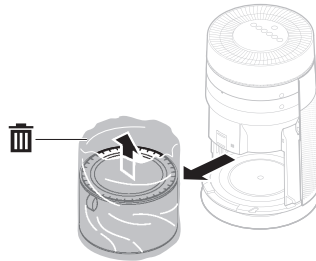

- 6 Install the filter in the appliance.
 - Make sure that the handle faces upward.

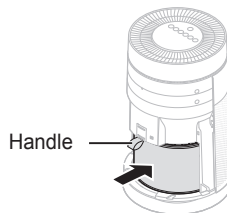

- 7 Insert the fixing parts at the bottom of the cover into the holes at the bottom of the appliance before you close the cover.

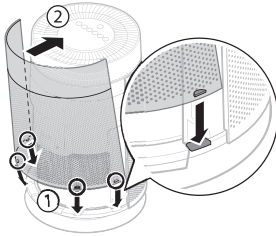

- 8 Assemble the appliance in the reverse order of disassembly after cleaning the appliance and replacing the filter.

! CAUTION

- Failure to remove the supports may affect the performance of the appliance. Please be sure to remove it before use.
- Make sure that you remove the filter's vinyl prior to use otherwise it may result in appliance malfunction.
- Pay attention to the direction of the filter when you install the filter otherwise it may cause malfunction or failure of the appliance.

Remote Controller

Inserting Battery

- 1 With the backside of the remote controller facing up, remove the battery tray from the remote controller.

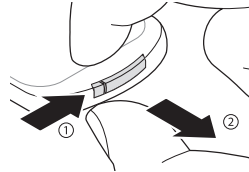

- 2 Insert the battery provided with the appliance to the tray.
 - The (+) electrode of the battery must face upward.

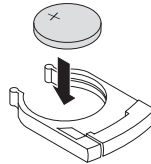

- 3 Insert the battery tray to the remote controller.

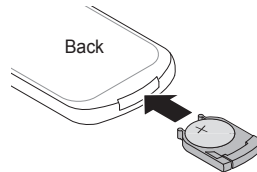

NOTE

- If the battery runs out of charge, replace it with a new one (CR2025).
- If the remote controller does not work as expected, try to replace the battery or check the polarity (+, -) of the battery. If the problem continues, contact the Service Centre.
- Dispose of the used battery according to the environmental regulations.

Transporting or Moving the Appliance

Transport the appliance in a well-secured and upright position. Impacts may cause appliance damage.



Hold the bottom of the product with both hands to move the product safely.

- Dropping the appliance may cause personal injury or appliance malfunction.
- Do not hold the outer cover when you carry the appliance. The cover may open accidentally, causing the appliance to drop.

When moving or storing the appliance, wrap the power cord around the base of the appliance to prevent personal injury, damage to the cord or damage to floors.

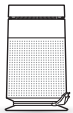

Installing the Appliance

Install the appliance on a strong level surface. Installing the appliance on a weak or tilted surface may cause noise and vibration or tipping, resulting in injury.

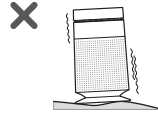

Allow a 1 m clearance between the appliance and surrounding surfaces or objects. The air inlet needs space to function properly.

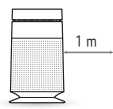

Install the product where you can easily remove the power plug.

Otherwise, electric shock or fire may be caused.

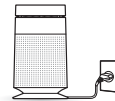

The performance of the appliance may differ depending on the operating environment (such as temperature and humidity).

- 40–70 % of humidity is recommended for optimal performance.



OPERATION

Appliance Overview

Front View

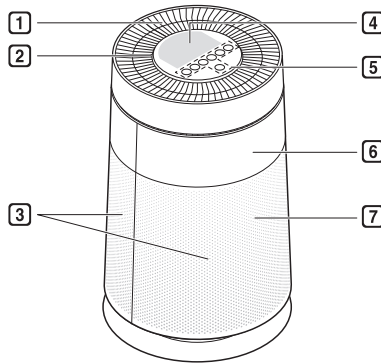

1 Air outlet/Clean booster

- It discharges purified air through the filter.
- You can control the direction of the air so that it reaches every corner of the room.

2 Light of air quality

It displays the overall air quality using a colored light.

3 Air inlet (front and rear covers)

Air goes into the air purifier through the inlet. You may remove the front or rear cover separately.

4 Status display panel

Use it to check the settings of the appliance and the air quality.

5 Control Panel

Use it to set the appliance functions.

6 Receiver for Remote controller Signal

7 Air Ionizer

- It generates negative ions and minimizes harmful bacteria in the air.
- It is built in the air purifier.

- The appearance or components of the appliance may differ depending on the model.

Back View

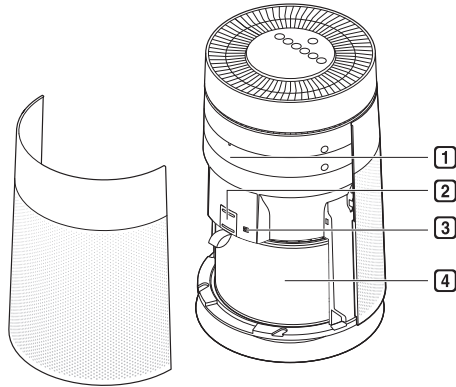

1 Smart Diagnosis Part

In the event of a malfunction or failure, you can use the Smart Diagnosis option to check the appliance condition.

2 PM1.0 (particles with a diameter between 1.0 and 2.5 micrometers) Sensor

It detects the concentration of particles.

3 Odour (Gas) Sensor

It detects a odour (gas).

4 Filter

It minimizes allergic materials, fine particles, possible sources of sick house syndrome, smog and other odour.

Filter System

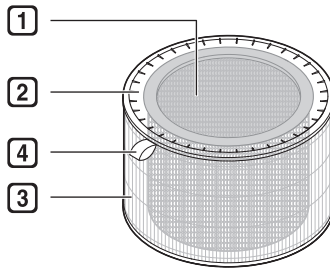

1 Deodorizing Care Filter

It minimizes harmful odour (gas) that are generated in everyday life such as bathroom smell, cigarette smoke (smell) and food smell.

2 Allergen Collection Care Filter

It minimizes PM1.0 and cigarette smoke from the air.

3 Ultra-fine Filter

It is attached on the exterior of the Allergen Collection Care Filter, primarily minimizing large particles floating in the air, including pet hair.

4 Filter Handle

Use it to separate the filter from the appliance.

NOTE

- Keep the windows or doors closed while using the product. However, if you operate the product for a long time in a closed space, carbon dioxide concentration may rise. So be sure to ventilate the indoor air regularly.
- Carbon monoxide (CO) is a harmful gas that is mainly introduced from outside and cannot be removed with a filter.
- The deodorization function of the air purifier operates by trapping the odour (gas) in the filter. If you use the product for a long time in a room with excessive odour, the performance of the filter may drop significantly. The Deodorizing Care Filter may sometimes become the source of excessive odour if used for a long time in a room with excessive odour.
- If excessive odour is present in the room, first ventilate the indoor air to remove the odour. Then use the air purifier to minimize the remaining odour.
- Do not throw the filter or use it for other purposes.

Control Panel

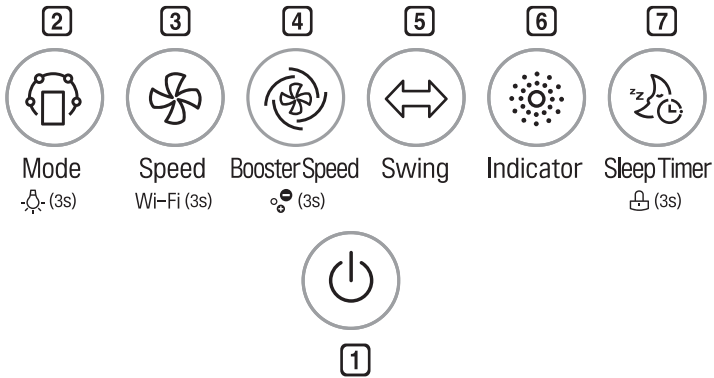

1 Start/Stop Button

You can start or stop the operation.

2 Mode Button

Use it to set the operation mode.

- Press and hold the button for 3 seconds or more to turn on/off the Light of air quality.

3 Speed Button

It allows you to adjust the air flow of the product.

- Press and hold the button for more than 3 seconds to activate the Wi-Fi registration mode.
- Buttons to turn Wi-Fi off
Pressing and holding the **Start/Stop** button and the **Speed** button at the same time for more than 3 seconds turns off Wi-Fi. After finishing the appliance registration and while Wi-Fi is off, pressing and holding the **Speed** button for more than 3 seconds turns on Wi-Fi so that you can control the appliance using a smartphone that has it registered.

4 Booster Speed Button

It allows you to adjust the air flow of the clean booster.

- Press and hold it for 3 seconds or more to turn on or off the air ionizer.

5 Swing Button

It allows you to set the clean booster to turn left or right.

6 Indicator Button

You can check the concentration of the particulate matter by its particle size.

7 Sleep Timer Button

Use it to schedule the time to turn off the appliance.

- Press and hold it for 3 seconds or more to lock or unlock the Control Panel buttons.

Status Display Panel

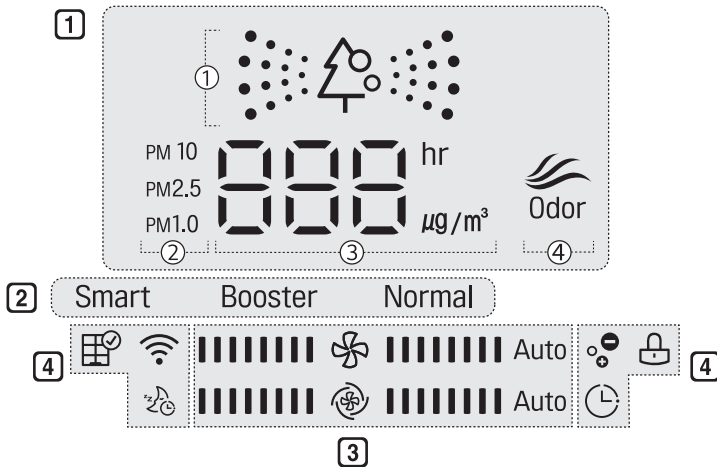



1 Display of air quality

- ① Overall air quality (color)
- ② Particulate matter (color)
- ③ Concentration of particles or sleep timer time
- ④ Concentration of odour (color)







2 Displays operating mode

3 Displays speed and booster speed

 Speed: Displays the air purifier's air flow.

 Booster Speed: Displays the clean booster's air flow.

4 Icons

Icon	Description
	It turns on when it is time to replace the filter.
	It turns on when the Wi-Fi function is activated.
	It turns on when the sleep timer function is activated.
	It turns on when the reservation for turning on/off the appliance is set in the LG ThinQ application.
	It turns on when the control panel is locked.
	It turns on when the air ionizer turns on.

Using Remote Controller

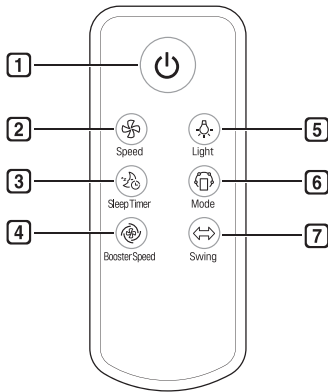

1 Start/Stop Button

You can start or stop the operation.

2 Speed Button

It allows you to adjust the air flow of the product.

3 Sleep Timer Button

Use it to schedule the time to turn off the appliance.

4 Booster Speed Button

It allows you to adjust the air flow of the clean booster.

5 Light Button

Use it to turn on or off the Light of air quality.

6 Mode Button

Use it to set the operation mode.

7 Swing Button

It allows you to set the clean booster to turn left or right.

NOTE

- To use the remote controller, direct the signal sending area of the remote controller toward the signal reception area of the appliance.
- If you are away from the appliance (front) by more than 7 m, the remote controller may not work.
- If the remote controller does not work even after replacing the battery, contact the nearest service centre.
- The remote controller may not work properly where there is a strong light, such as those from a 3-wavelength fluorescent lamp or a neon sign.
- If you lost the remote controller, you can purchase a new one in a nearby service centre.

Getting Started

Press the **Start/Stop** button to start the operation.

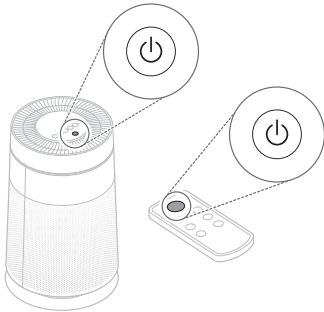

NOTE

- If you operate the product for the first time, it enters **Booster** mode.
- If you stop and resume the operation, it starts cleaning with the mode you selected last time. Even if power is lost due to a blackout, the appliance remembers the mode you used last time.
- Once the operation starts, the sensor stabilizes (for approx. 30 seconds) before the particles concentration is displayed. During the sensor stabilization period, you will see  (ready) on the status display panel. You can specify the sensor stabilization time in the 'Air quality sensor start time' option in the LG ThinQ application.
 - 'Always operate': You can check the air quality even when the product is not operated.
 - 'Operate only during the operation': You can check the air quality only when the product is operating.

Using Smart Mode

It automatically controls the operation mode and air flow based on the overall air quality.

Press **Mode** button to choose **Smart** mode.

- Each time you press the button, the operation mode changes in the following order: **Smart** → **Booster** → **Normal**.

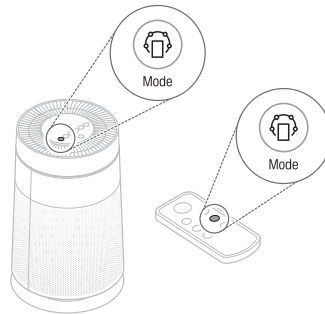

NOTE

- While in **Smart** mode, the **Speed**, **Booster Speed** and **Swing** buttons do not work.
- **Smart** mode operates either the clean booster or the air purifier to adapt to the air quality.

Using Booster Mode

The clean booster cleans the air and quickly sends it to a long distance to circulate the indoor air.

Press the **Mode** button to choose **Booster** mode.

- Each time you press the button, the operation mode changes in the following order: **Smart** → **Booster** → **Normal**.

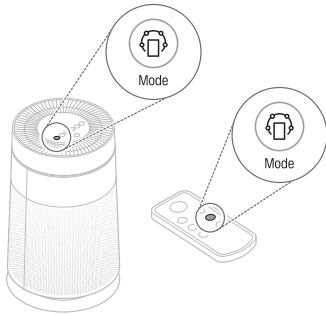

Using Normal Mode

This is a basic operation mode for air purification, enabling you to control the Air flow as desired.

Press the **Mode** button to choose **Normal** mode.

- Each time you press the button, the operation mode changes in the following order: **Smart** → **Booster** → **Normal**.

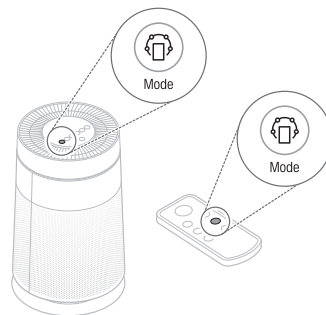

NOTE

- If you choose **Booster** mode, the clean booster rises at the 55° and pushes the air forward to circulate the indoor air.
- If you happen to unplug the power cord from the outlet before the Clean Booster closes completely, plug in the cord again. The Clean Booster will swing left and right and then close completely.

Adjusting the Air Purifier Fan Speed

You can adjust the air flow of the air purifier. Press the **Speed** button during the operation.

- Each time you press the button, the speed changes in the following order: Auto → Low → Middle → High → Turbo.

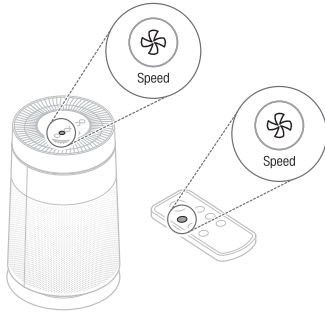

Adjusting the Clean Booster Fan Speed

You can adjust the air flow of the clean booster.

While in **Booster** mode, press the **Booster Speed** button.

- Each time you press the button, the speed changes in the following order: Auto → Low → Middle → High → Turbo.

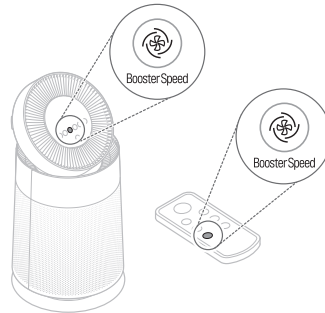

Displaying Air Purifier Speed

If you adjust the speed, it is displayed on the status display panel. It increases by 2 grids at a time.

[Example of Air Purifier Speed 'Middle']



NOTE

- The speed is set to **Auto** when you first start the operation. **Auto** mode controls the wind speed automatically according to the contamination level of the indoor air.
- **You can control the wind speed in the Booster modes and Normal modes.**

Displaying Booster Speed

If you adjust the booster fan speed, it is displayed on the status display panel. It increases by 2 grids at a time.

[Example of Booster Speed 'Middle']



NOTE

- If you choose **Auto**, the fan inside the clean booster is adjusted according to the speed of the air purifier. For example, if you change the speed of the air purifier to 'Low', the booster fan speed is changed to 'Low' as well.
- You may control the booster fan speed only in **Booster** mode. In the other modes, you will hear a warning sound and won't be able to control the function.

Rotating the Clean Booster

The clean booster rotates left and right.

While in **Booster** mode, press the **Swing** button.

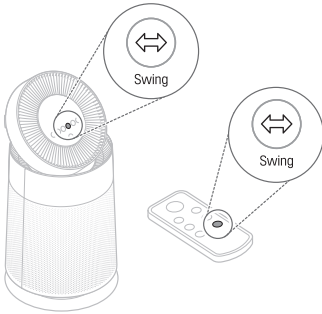

NOTE

- The rotating angle of the clean booster is 35°.
- You may use the clean booster rotation function only in **Booster** mode. In the other modes, you will hear a warning sound and won't be able to control the function.

Checking the Air Quality

You can check the cleanliness of the indoor air by looking at the Light of air quality and the status display panel.

Understanding the Overall Air Quality

The overall air quality is calculated based on the particles and odour (gas) concentrations and is categorized into 4 levels including green, yellow, orange or red depending on the contamination of the air.

Color	Overall Air Quality	Concentration of PM ($\mu\text{g}/\text{m}^3$)			Concentration of odour	
	State	PM10 (coarse particles)	PM2.5 (fine particles)	PM1.0 (particles with a diameter between 1.0 and 2.5 μm)	State	Level
Red	Poor	255 or more	56 or more	56 or more	Very strong	4
Orange	Unhealthy	155~254	36~55	36~55	Strong	3
Yellow	Moderate	55~154	13~35	13~35	Normal	2
Green	Good	54 or less	12 or less	12 or less	Weak	1

NOTE

- The color of overall air quality is determined based on whichever is worse between the particles concentration and odour (gas) concentration.
- PM (particulate matter) concentration is displayed in increments of 1 unit, from 8 to 999. PM concentration values are based on the data sheet provided by the sensor manufacturer.
 - Differences in PM concentration values may be the result of different methods of measuring or differences in the actual PM concentration levels.
 - The PM concentration measurement was tested using LG Electronics' standard test materials.
- The overall air quality level is a result of both PM concentration and the odour level. It may differ from the PM10, PM2.5 and PM1.0 concentration levels.

Checking the Air Quality Using the Light of air quality

Four different colors are used to indicate the overall air quality based on the particles concentration and odour (gas) concentration.

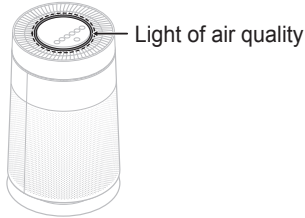

NOTE

The Light of air quality turns on white for the sensor stabilization period (30 seconds). The odour (gas) sensor is stabilized 2 minutes after you start the operation. During this period, the odour (gas) concentration is not reflected in the overall air quality.

Turning on/off the Light of air quality

You can press and hold the **Mode** button for 3 seconds or more to turn it on/off.

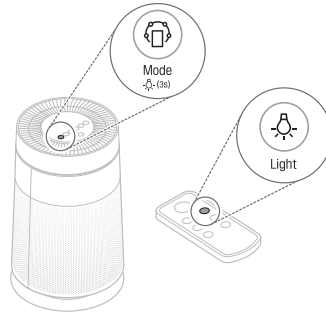



NOTE

- When the sleep timer is set, the Light of air quality turns off.
- If you turn on the Light of air quality after setting the sleep timer, you will see the overall air quality on the status display panel as well as on the Light of air quality.

Checking Air Quality on the Status display panel



You may check the overall air quality, particles concentration, and odour concentration on the status display panel.

- **Overall air quality:** You can check the  color (overall air quality) on the status display panel to determine the overall air quality.
- **Particles concentration:** You can check the particles concentration by looking at the particles concentration value and the particle size indicator color. It shows the worst status among the PM10 / PM2.5 / PM1.0.
 - If the particles concentrations of all categories are 'good', the concentration of the 'PM10' is displayed.
 - If it is worse than 'moderate', the color and concentration of the particles with the highest contamination level are displayed. If they share the same contamination level, the contamination level is displayed according to the following order: PM1.0, PM2.5 and PM10.
- **Odour concentration:** You can check the  color (odour concentration) on the status display panel to determine the odour concentration.

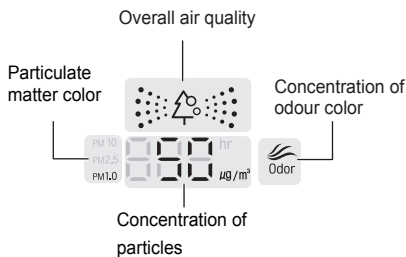
[Example of the Display Showing Air Quality]



The above picture displays **PM10/PM2.5/PM1.0**, meaning that the concentration of particles with a diameter between 1.0 and 2.5 micrometers is higher than those of coarse particles and fine particles.

While the color of the particulates matter is solely determined based on the particles concentration and the color of the  (odour concentration) is solely determined based on the odour concentration, the color of the  (overall air quality) is determined based on the worse cause between the particles and odour.

If the odour is 'normal' and the PM1.0 concentration is **50 µg/m³**, which is 'unhealthy', the overall air quality is displayed in orange as the worst cause is the particles. On the other hand, if the odour is 'very strong', the overall air quality is displayed in red because the odour becomes the worst cause.

Checking the Particles Concentration

You can check the particulate matter concentration by its particle size.

Press the **Indicator** button during the operation.

- Whenever you press the button, the display changes in the following order: **PM10** → **PM2.5** → **PM1.0**.
- The concentration of the selected particles is displayed for about 10 seconds.

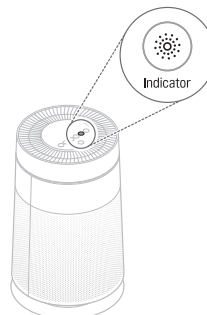

NOTE

- The overall air quality level is a result of both PM concentration and the odour level. It may differ from the PM10, PM2.5 and PM1.0 concentration levels.
- Even two products placed in the same space could measure the concentration of particles differently due to air circulation.
- The chemicals contained in air fresheners, perfumes, deodorizers or cosmetics may affect the overall air quality display.
- The particles concentration displayed may change with environmental factors such as the presence of sofas, beds, carpets, vacuum cleaners, humidity, smoke, bugs, pets or cooking oils.
- The PM concentration may be affected by changes in the outside environment such as construction, heavy traffic or pollen. The micro particles concentration could be higher near outside doors, windows, vents or in areas where outside air enters.
- Use **ONLY** water to clean the sensor. Using anything else could cause appliance failure.
- The concentration of particles could be affected by cooking or using humidifiers, sprays or other products which generate steam or fine particles.

Using the Air Ionizer

To generate ions to minimize various bacteria from the air.

Press the **Booster Speed** button for more than 3 seconds while operating.

-  (Air ionizer) is displayed on the status display.

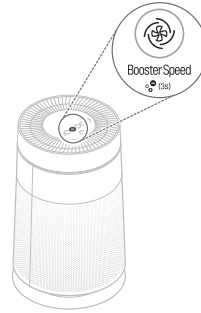

NOTE

- When the operation is stopped, the air ionizer function can not be used.
- The air ionizer function is available in all operating modes.

Setting the Sleep Timer

You can set the appliance to stop automatically after running for the duration you set.

Press the **Sleep Timer** button during the operation.

- Each time you press the button, the Sleep Timer changes in the following order: After 2 hours → After 4 hours → After 8 hours → After 12 hours → Cancel.
- Once the sleep timer is set, the status display panel displays only the  sleep timer icon except for a few other icons.

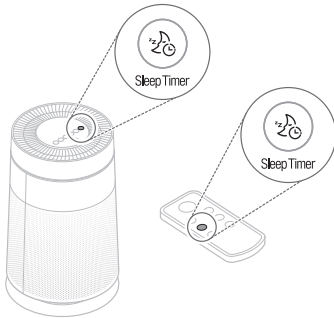

NOTE

- For your deep sleep, the speed is set to Low by default for a certain period of time. After the time passes, the speed is controlled automatically depending on the air quality.
- Even when the sleep timer is set, you can still change the speed by pressing the **Speed** button.
- If you press the **Sleep Timer** button once more while the sleep timer is set, you can check the preset time and press the button repeatedly to cancel the sleep timer.
- The sleep timer remains on even if the power goes off or if there is a blackout.

Locking the Control Panel Buttons

You can lock the buttons on the Control Panel to prevent the appliance from operating due to unforeseen reasons, such as a child manipulating the buttons.

Press the **Sleep Timer** button for at least 3 seconds during the operation.

-  (Lock) is displayed on the status display panel.

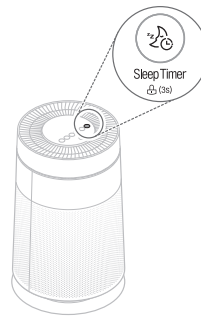

NOTE

- You can turn off the lock function in the same way as turning it on.
- The control panel can be locked even when the appliance is not operated.
- If you pull out the power plug in lock set status, the lock function is cleared.
- You can use the remote controller even when the control panel is locked.

SMART FUNCTIONS

LG ThinQ Application

The LG ThinQ application allows you to communicate with the appliance using a smartphone.

LG ThinQ Application Features

Smart Diagnosis

If you experience a problem while using the appliance, this smart diagnosis feature will help you diagnose the problem.

Settings

Allows you to set various options on the appliance and in the application.

NOTE

- If you change your wireless router, Internet service provider, or password, delete the registered appliance from the LG ThinQ application and register it again.
- The application is subject to change for appliance improvement purposes without notice to users.
- Functions may vary by model.

Before using LG ThinQ Application

This feature is only available on models with Wi-Fi function.

- 1 Check the distance between the appliance and the wireless router (Wi-Fi network).
 - If the distance between the appliance and the wireless router is too far, the signal strength becomes weak. It may take a long time to register or installation may fail.

- 2 Turn off the Mobile data or Cellular Data on your smartphone.

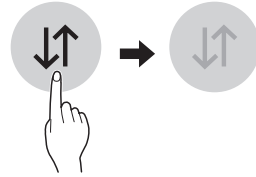

- 3 Connect your smartphone to the wireless router.

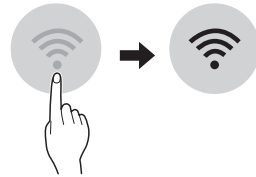

NOTE

- To verify the Wi-Fi connection, check that Wi-Fi  icon on the control panel is lit.
- The appliance supports 2.4 GHz Wi-Fi networks only. To check your network frequency, contact your Internet service provider or refer to your wireless router manual.
- LG ThinQ is not responsible for any network connection problems or any faults, malfunctions, or errors caused by network connection.
- If the appliance is having trouble connecting to the Wi-Fi network, it may be too far from the router. Purchase a Wi-Fi repeater (range extender) to improve the Wi-Fi signal strength.
- The Wi-Fi connection may not connect or may be interrupted because of the home network environment.
- The network connection may not work properly depending on the Internet service provider.
- The surrounding wireless environment can make the wireless network service run slowly.

- The appliance cannot be registered due to problems with the wireless signal transmission. Unplug the appliance and wait about a minute before trying again.
- If the firewall on your wireless router is enabled, disable the firewall or add an exception to it.
- The wireless network name (SSID) should be a combination of English letters and numbers. (Do not use special characters.)
- Smartphone user interface (UI) may vary depending on the mobile operating system (OS) and the manufacturer.
- If the security protocol of the router is set to WEP, you may fail to set up the network. Please change it to other security protocols (WPA2 is recommended) and register the product again.

Wireless LAN Module Specifications

Model	LCW-003
Frequency Range	2412 - 2472 MHz
Output Power (Max)	IEEE 802.11b: 18.37 dBm IEEE 802.11g: 17.67 dBm IEEE 802.11n: 17.67 dBm

Wireless function S/W version : V 1.0

For consideration of the user, this device should be installed and operated with a minimum distance of 20 cm between the device and the body.

Installing the LG ThinQ Application

Search for the LG ThinQ application from the Google Play Store or Apple App Store on a smartphone. Follow instructions to download and install the application.

Open Source Software Notice Information

To obtain the source code under GPL, LGPL, MPL, and other open source licenses, that is contained in this product, please visit <http://opensource.lge.com>.

In addition to the source code, all referred license terms, warranty disclaimers and copyright notices are available for download.

LG Electronics will also provide open source code to you on CD-ROM for a charge covering the cost of performing such distribution (such as the cost of media, shipping, and handling) upon email request to opensource@lge.com. This offer is valid for a period of three years after our last shipment of this product. This offer is valid to anyone in receipt of this information.

Smart Diagnosis

This feature is only available on models with the  logo.

Use this feature to help you diagnose and solve problems with your appliance.

NOTE

- For reasons not attributable to LGE's negligence, the service may not operate due to external factors such as, but not limited to, Wi-Fi unavailability, Wi-Fi disconnection, local app store policy, or app unavailability.
- The feature may be subject to change without prior notice and may have a different form depending on where you are located.

Using LG ThinQ to Diagnose Issues

If you experience a problem with your Wi-Fi equipped appliance, it can transmit troubleshooting data to a smartphone using the **LG ThinQ** application.

- Launch the **LG ThinQ** application and select the **Smart Diagnosis** feature in the menu. Follow the instructions provided in the **LG ThinQ** application.

Using Audible Diagnosis to Diagnose Issues

Follow the instructions below to use the audible diagnosis method.

- Launch the **LG ThinQ** application and select the **Smart Diagnosis** feature in the menu. Follow the instructions for audible diagnosis provided in the **LG ThinQ** application.

- 1 Press and hold the **Indicator** button for 5 seconds or more to execute the Smart Diagnosis function.

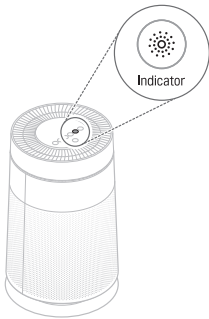

- 2 Hold the phone on the  logo on the back of the appliance.

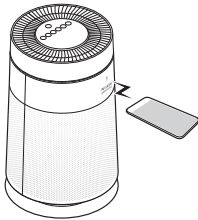

- 3 After the data transfer is complete, the diagnosis will be displayed in the application.

NOTE

- For best results, do not move the phone while the tones are being transmitted.

MAINTENANCE

⚠ WARNING

- You must stop operating the appliance and unplug it before you clean and replace the filter.
- Do not spray water directly on the appliance.

- You may also request cleaning or replacement of the filter to the Service Centre. You will be charged a certain fee for filter cleaning and replacement services.
- If there are no changes to the particles concentration on the status display panel, clean the sensor regardless of the cleaning frequency (2 months) of the PM1.0 sensor.

Scheduled Maintenance

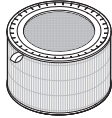
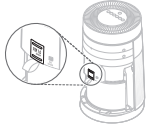
Component	Cleaning Frequency	Replacement Frequency
 Filter	Only ultra-fine filter If contaminated, clean the ultra-fine filter with a vacuum cleaner or soft brush.	The whole filter 1 year
 PM1.0 sensor	2 months	-

NOTE

- The operating environment and operation hours may affect the cleaning frequency. We recommend that you should clean it more often in a dusty environment.
- If you do not clean the product according to the cleaning frequency, you may experience a bad odour and poor performance.
- A filter is a consumable item. Therefore you must buy a new one for replacement when it has reached the end of its lifespan even during the warranty period. Contact the LG Electronics Service Centre or Consumables shop on the LG Electronics site (www.lg.com).

Alerts on the Status display panel

When you see an alert message on the status display panel, do the following:

Alert	Measures
	Replace the filter.

NOTE

Filter replacement alerts appear based on the maximum usage time, taking into account the operating hours of the product. The replacement frequency is determined by the operating hours and environment.

⚠ CAUTION

- Do not disassemble the clean booster arbitrarily.
- Do not unscrew the 2 screws fixing the clean booster grille on the back while the product is running.



- If the clean booster cover comes apart, secure it by aligning the 4 hooks with the slots before you use the product.

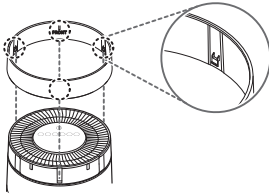

Cleaning the Exterior

- 1** Remove dust from the air inlet and outlet using a vacuum cleaner.

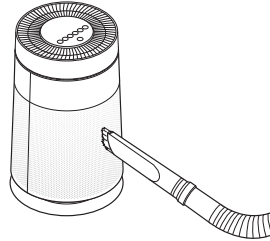

- 2** Wipe the exterior with soft cloth.

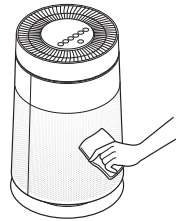

NOTE

If you find it difficult to clean the front and rear covers, separate them first and wash with water. Then, dry them completely under the shade.

Cleaning the Filter

- 1 Separate the cover from the appliance.
- 2 Remove dust from the ultra-fine filter with a vacuum cleaner or soft brush.

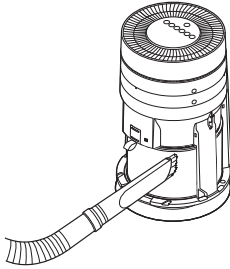

Replacing the Filter

- 1 Remove the cover and replace the filter.
 - To avoid polluting the surroundings when replacing the filter, place a newspaper on the floor before you remove the filter.
- 2 Once you have replaced the filter, disable the filter replacement alert.

Disabling a Filter Replacement Alert

Press and hold the **Speed** and **Indicator** buttons simultaneously for 3 seconds or more.

- The  (Filter Replacement Alert) is disabled and the replacement alarm is reset.

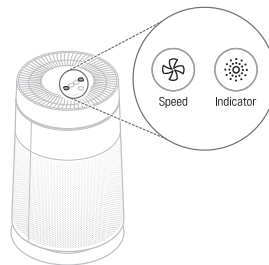

NOTE

The filter replacement alert is disabled automatically if 24 hours have passed since it was displayed or if the product is disconnected from the power source.

Cleaning the Particles Sensor

PM1.0 sensor detects the fine particles as well as coarse particles. Therefore, you need to clean its lens regularly.

- 1 Remove the rear cover from the appliance.
- 2 Open the sensor cover.

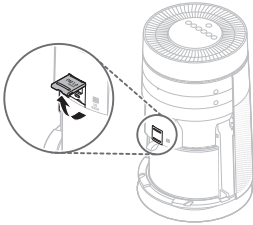

- 4 Close the sensor cover.

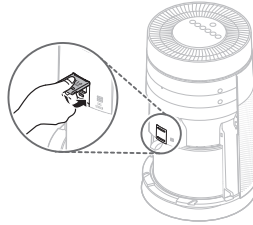

NOTE

Do not wipe the sensor with material other than water. It may cause a appliance failure.

- 3 Clean the lens with the cotton swab soaked with water and clean it again with a dry cotton swab.

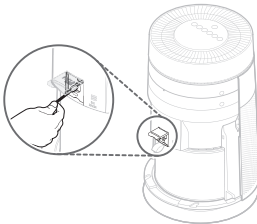

Storage

If the appliance is not used for a long period of time, store it at a shaded and dry place.

- 1** Operate the product in Normal mode for one hour or more on a fine day.
 - This removes the moisture and prevents molds from building up inside the product.
- 2** Turn off the power and unplug it from the electrical outlet.
 - Wind the power cord around the bottom of the appliance.
- 3** Package the appliance to prevent the dust or foreign substance from entering the appliance. Store the packaged appliance at a shaded place.

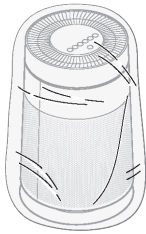

! CAUTION

Do not store the appliance at a humid place or at a place exposed to the direct sunlight. Otherwise the appliance may be deformed, malfunction or generate odour.

TROUBLESHOOTING

If a failure occurs in the appliance, check the following before contacting the Service Centre.

Symptoms	Cause	Solution
The appliance does not operate.	Is the power plug unplugged from the outlet?	<ul style="list-style-type: none"> Plug it into the outlet properly.
Fan is noisy even on the lowest speed.	Did dust accumulate in the ultra fine filter?	<ul style="list-style-type: none"> Clean the ultra fine filter properly.
	Did dust accumulate in the Allergen Collection Care Filter?	<ul style="list-style-type: none"> Replace the whole filter.
The indoor air is not purified well enough.	Is the indoor contamination severe?	<ul style="list-style-type: none"> Ventilate the indoor air before you use the product.
	Did dust accumulate in the ultra fine filter?	<ul style="list-style-type: none"> Clean the ultra fine filter properly.
	Did dust accumulate in the Allergen Collection Care Filter?	<ul style="list-style-type: none"> Replace the filter.
	Are you using it in a place that is too spacious or too open?	<ul style="list-style-type: none"> Use a product that fits the size of the room. Avoid a well-ventilated place such as a gate, window, etc.
	Is there any obstacle nearby?	<ul style="list-style-type: none"> Remove the obstacle.
	Is the appliance installed at a corner?	<ul style="list-style-type: none"> Move the appliance and install it again.
There is a odour, but the Light of air quality does not change.	Is the Light of air quality turned on red or orange?	<ul style="list-style-type: none"> The color of overall air quality is determined based on whichever is worse between the particles concentration and odour (gas) concentration. Check if the particles concentration is worse than before. The Odour(gas) sensor is designed to detect harmful gases. Strong food odours may not register as harmful, but the Deodorizing Care Filter will minimize them.

Symptoms	Cause	Solution
The Light of air quality continues to stay red.	Doesn't the color change even if it is moved to a clean room?	<ul style="list-style-type: none"> • If the amount of the odour is more than the capacity of the product, the display may not change. • Clean the sensor area. • Remove the power plug from the outlet and reconnect it one minute later.
	Did you use a spray near the product?	<ul style="list-style-type: none"> • Do not use a spray near the product.
The buttons on the control panel do not work.	Is the  (Lock) turned on on the status display panel?	<ul style="list-style-type: none"> • Press and hold the Sleep Timer button for 3 sec. or longer to disable the lock function.
The concentration of the particles does not change.	Is there a foreign substance on the sensor?	<ul style="list-style-type: none"> • Clean the PM1.0 sensor.
	Is the product used in a closed space?	<ul style="list-style-type: none"> • In a closed space, the cleanliness level may continue to stay the same without change.
The concentration of particles continues to remain high.	Does the air continue to flow in from the outside to the location where the product is installed?	<ul style="list-style-type: none"> • In an environment where outside air is supplied continuously, the concentration may continue to remain high.
The overall air quality color does not match the particles concentration value.	Does the color of the overall air quality match the color that indicates the odour concentration?	<ul style="list-style-type: none"> • The overall air quality is displayed by evaluating the odour and particles concentration comprehensively. • Even if the particles concentration is low, if the odour is strong, the overall air quality color may not match the particles concentration value.
The appliance makes a sudden loud noise while operating.	Is the operation mode set to Smart mode or Speed is set to Auto mode?	<ul style="list-style-type: none"> • It may make a sudden noise as it automatically adjusts the air flow depending on indoor air quality.

Symptoms	Cause	Solution
A strange odour comes out from the air outlet as well as the filter.	Did you purchase the appliance lately?	<ul style="list-style-type: none"> The odour of activated charcoal is not harmful. This is similar to the odour you may experience in a brand new car. We assure it will go away 1-2 weeks after its first use.
	Is the product used at a place with a lot of smoke or odour?	<ul style="list-style-type: none"> In a place with a lot of smoke or odour, the air cleaning function may deteriorate. Ventilate the room first and then use the product.
	Does the filter have a bad odour?	<ul style="list-style-type: none"> Replace the filter. The filter replacement frequency may differ depending on the usage environment.
	Is the product installed in an environment where a lot of odour occurs?	<ul style="list-style-type: none"> If you use the product for a long period of time while you cook or broil fish/meat, the filter lifespan may be rapidly decreased. If possible, open the window for ventilation while cooking, and use the product to minimize the odour left after the ventilation.
The clean booster is not working.	Is the operation mode set to the Clean Booster mode?	<ul style="list-style-type: none"> The booster fan speed and booster fan rotation functions work only in the Clean Booster mode.
A noise is generated when I start or stop the clean booster.	-	<ul style="list-style-type: none"> It means that the clean booster is trying to look for the correct location.
The Light of air quality is not illuminated.	-	<ul style="list-style-type: none"> Check if the light of air quality is turned off.
	Is the Sleep Timer set?	<ul style="list-style-type: none"> The light of air quality is turned off when the sleep timer function is activated.

Symptoms	Cause	Solution
<p>I can't connect to the appliance in the LG ThinQ app.</p>	<p>Is the power plug unplugged from the outlet?</p>	<ul style="list-style-type: none"> • Plug in the power cord of the appliance.
	<p>Is the wireless router connected with the appliance not working?</p>	<ul style="list-style-type: none"> • Power off the wireless router and on again. • Check if there is an Internet connection problem with the router.
<p>I can't register the appliance in the LG ThinQ app.</p>	<p>Is the appliance too far away from the wireless router?</p>	<ul style="list-style-type: none"> • Move the wireless router near the appliance.
	<p>Is your wireless router working properly?</p>	<ul style="list-style-type: none"> • Some carriers provide routers that are available to their members only. If you have an outdated model, contact your carrier to have it replaced with a newer one.
<p>The particles concentration levels are different between the appliance and the LG ThinQ app.</p>	<p>Are you looking at the same particles?</p>	<ul style="list-style-type: none"> • Make sure that the levels of the PM1.0/PM2.5/PM10 are displayed consistently between the LG ThinQ app and your appliance. • The difference in the values could be caused by the difference in update time between the LG ThinQ app and the appliance.

APPLIANCE SPECIFICATIONS

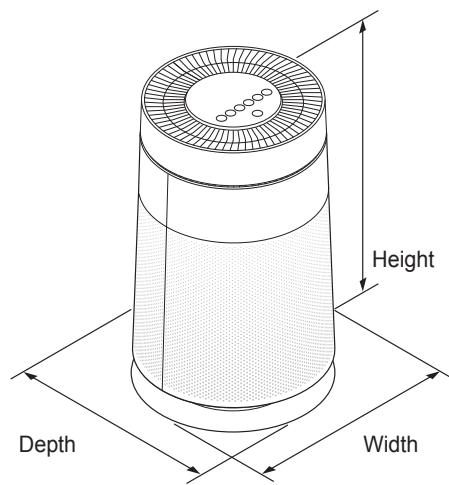

The external appearance and dimensions of the appliance are subject to change without prior notice.

Model	AS65GD Series
Power	220-240 V~ 50 / 60 Hz
Exterior dimensions (Width X Height X Depth)	When the clean booster is not running: 360 mm x 587 mm x 360 mm
	When the clean booster is running: 360 mm x 824 mm x 360 mm

MEMO

MEMO

MEMO

MEMO

